

VOLVO WHEEL LOADERS
L110G, L120G

18,2-20,8t 259-272 hp



A PASSION FOR PERFORMANCE.

At Volvo Construction Equipment, we're not just coming along for the ride. Developing products and services that raise productivity – we are confident we can lower costs and increase profits for industry experts. Part of the Volvo Group, we are passionate about innovative solutions to help you work smarter – not harder.

Helping you to do more

Doing more with less is a trademark of Volvo Construction Equipment. High productivity has long been married to low energy consumption, ease of use and durability. When it comes to lowering life-cycle costs, Volvo is in a class of its own.

Designed to fit your needs

There is a lot riding on creating solutions that are suited to the particular needs of different industry applications. Innovation often involves high technology – but it doesn't always have to. Some of our best ideas have been simple, based on a clear and deep understanding of our customers' working lives.



You learn a lot in 175 years

Over the years, Volvo has advanced solutions that have revolutionized the use of construction equipment. No other name speaks Safety louder than Volvo. Protecting operators, those around them and minimizing our environmental impact are traditional values that continue to shape our product design philosophy.

We're on your side

We back the Volvo brand with the best people. Volvo is truly a global enterprise, one that is on standby to support customers quickly and efficiently – wherever they are.

We have a passion for performance.

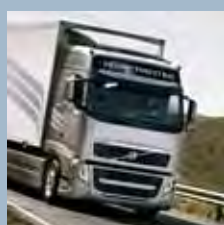

Volvo Trucks

Renault Trucks

Mack Trucks



UD Trucks



Volvo Buses



Volvo Construction Equipment



Volvo Penta



Volvo Aero



Volvo Financial Services

FLEXIBLE, TO MEET YOUR NEEDS.

The new Volvo L110G and L120G wheel loaders are strong and versatile; purpose-built to move more material, with greater flexibility. Designed to work on any site, these efficient machines can use a range of Volvo attachments to handle all types of production – from quarries to road construction – making the Volvo L110G and L120G great ‘allrounder’ machines.



Parallel lift

Parallel lift enables you to get closer to the materials and raise them quickly, with smooth, horizontal stability. Load faster and more accurately to save time for increased productivity.

Load sensing hydraulics

Load-sensing hydraulics match power when it's needed for lower fuel consumption and high performance. Faster lift and tilt functions are achieved by variable-flow axial piston pumps, with high pump capacity for superior control of the load and attachments. Increased working hydraulic pressure enables greater lifting force.



Hydraulic attachment bracket

Volvo's hydraulic attachment bracket, VAB-STD, has been internationally ISO standardized. The bracket allows quick interchange of attachments for increased flexibility on site. The strong, open bracket design enables the operator to clearly see each attachment from the cab.



Productive TP linkage

Volvo's patented Torque Parallel linkage delivers high breakout torque throughout the entire range, including the highest lift position, making it ideal in applications such as log handling.

PURPOSE-BUILT TO PERFORM.



Optimized drivetrain

Volvo designed, Volvo manufactured – that applies to the whole machine. The engine, transmission, axles, hydraulics and steering are developed as one unit to provide optimized performance, to work harder and faster.

The Volvo L110G and L120G are built to perform precision-demanding applications with unbeatable productivity. All components are developed and manufactured by Volvo as one unit to provide optimized performance, lower fuel consumption and maximum reliability.

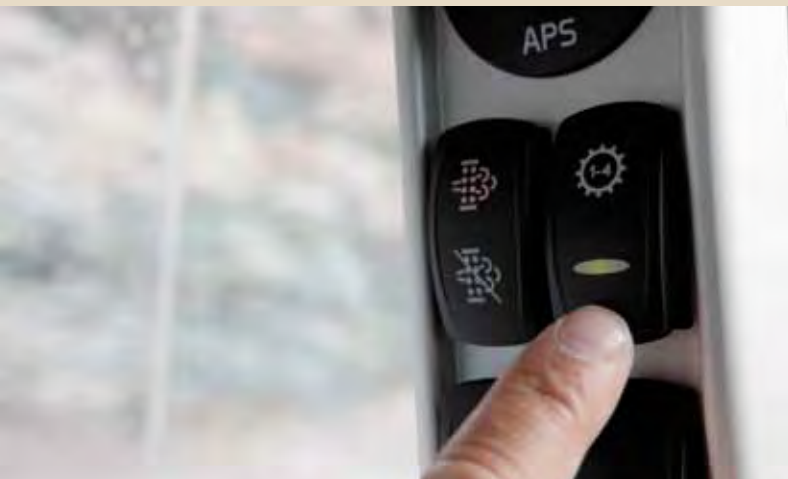

Fuel saving Automatic Power Shift

The Automatic Power Shift system means the machine always operates in the most suitable gear according to speed, kick down and engine braking. Fully Automatic Power Shift (FAPS) switches to 1st gear when additional power is required for lower fuel consumption.

Heavy duty axle

Volvo's heavy-duty wet brake axles promote a longer service life. Axle housings absorb all loads from the machine weight distribution, so the axle shafts only transmit torque to the hub reductions, reducing working stresses on the axle.



Differential lock for traction

The front axle is mounted to the front frame and equipped with an electro-hydraulic operated differential lock. Transfers 100% power to the wheels and reduces tire slippage to provide outstanding traction on soft and slippery ground.



CONSUMING LESS WHILE GIVING MORE.

Volvo machines are fuel efficient and environmentally responsible. Fuel consumption is significantly lowered in the L110G and L120G through Volvo's turbocharged Stage IIIB/ Tier 4 Interim engine, diesel particle filter to incinerate exhaust emissions and accelerator eco pedal to promote operator efficiency. More is achieved, less is wasted.

V-**ACT**

Fuel efficient Volvo V-ACT

Volvo Combustion Technology, V-ACT, is tailored for use in demanding applications. Fuel injection is electronically controlled based on temperature, pressure, load and engine speed in order to achieve optimal combustion. The result: high performance and low emissions.



Diesel particle filter

The Diesel Particulate Filter (DPF) includes a Diesel Oxidation catalyst function and an external regeneration burner, which works as you operate. The system temporarily holds the exhaust and then incinerates it, reducing carbon emissions. The process reduces emissions without stopping production.



Eco pedal

The eco pedal encourages the operator to engage the throttle pedal with ease to lower fuel consumption, by applying the appropriate amount of mechanical counter pressure (push-back). This economical pedal feature promotes operator efficiency by avoiding excessive fuel use.



Lowering emissions

High torque at low RPM is achieved for industry-leading performance. Fuel consumption is lowered by a common rail system, cooled exhaust, gas recirculation and particulate filter with active and passive regeneration. Volvo's 8 litre, 6-cylinder turbocharged diesel engine has low emission levels that meet Stage IIIB/ Tier 4 Interim engine requirements.

QUICK ACCESS, EASY MAINTENANCE.



Easy access to the engine

The engine hood is newly designed and can be electrically opened backwards for quick easy access to the engine for fast maintenance/cleaning. Large ventilation sections keep the engine cool for sustained performance and a wide opening angle allows for a better overview of the full engine compartment.

Time is money. That's why Volvo wheel loaders are built with quick access to service areas for easy maintenance. Contronics system inside the cab monitors the machine's performance for up-to-the-minute service diagnostics to keep your machine running for longer.

Contronics

Volvo Contronics is a computerized machine electronics and monitoring system. Continuously monitors the machine, operation and performance in real time. Provides diagnostic functions and information needed for optimal operation. Fast, easy electronic level checks. More uptime each day.

Maintenance-free cradles

The rear axle cradles are maintenance free. Rear-axle bridge connects the axle to the frame and includes two grease-lubricated-for-life roller bearings. Front bridge includes two oil bath, pre-filled-for-life bushings. Minimizes force on the axle and helps to maintain a low centre of gravity. Cradle oscillation pins are sealed to keep grease/oil in and dirt out for easy maintenance.



Hydraulic cooling fan

Hydraulically driven, electronically controlled cooling fan works only when needed to save fuel. The fan is located behind engine and radiator and speeds-up when necessary. Higher engine power, lower fuel consumption and lower sound levels are achieved.

KEEPING YOU FOCUSED AND IN CONTROL.

Air filter

The cab air intake is placed in a prime location – high in the cab, where the air is cleaner and further from outside dust. The easy-to-replace pre-filter separates coarse dust. Then 90% of the cab air is circulated through the main filter, giving the operator a breath of fresh air.

Electro Hydraulic Servo control

The servo controls are mounted on the operator seat, to keep them in place despite seat movement. The high quality controls allow the selection of easy settings from inside the cab such as: return to dig, boom and tilt detent.



Climate control

No matter what the weather does, Volvo keeps the operator at a pre-selected temperature with its in-cab climate control system. Select between Automatic Heat Control (AHC) or optional Air Conditioning (AC) to keep operators focused and productive.

Noise reduction

Thanks to noise and vibration dampening, inside the cab is quieter than outside, enabling the operator to concentrate on the task in hand, with minimal distraction.



Safe and roomy cab

Safety and visibility are at the forefront of design for Volvo's cab. The industry-tested and ROPS/FOPS-approved cab provides excellent all-round visibility. The operator can concentrate with ample room to stretch-out and still have room for storage.



Operators need to remain focused and sharp, however long their shift. Volvo's industry-leading cab provides a spacious, quiet and safe operator environment, whatever the conditions outside, helping operators to stay efficient, all day, every day.

CONNECT AND GO.

All genuine Volvo attachments are purpose-built with the same quality as the rest of the machine. They're designed as an integrated part of the wheel loader for which they were intended, their functions and properties perfectly matched to parameters such as link-arm geometry and breakout, rim pull and lifting force. That's why the machine and attachment work in perfect harmony, forming a dependable cohesive unit to get the job done – safely and efficiently.

Rehandling buckets increase fuel efficiency:

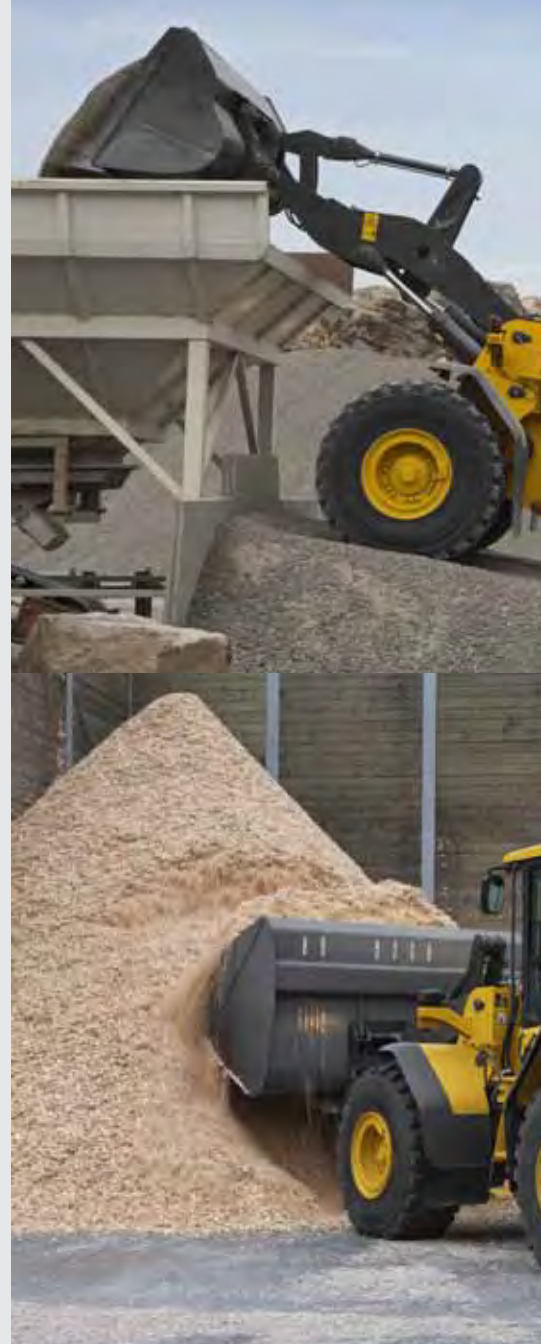
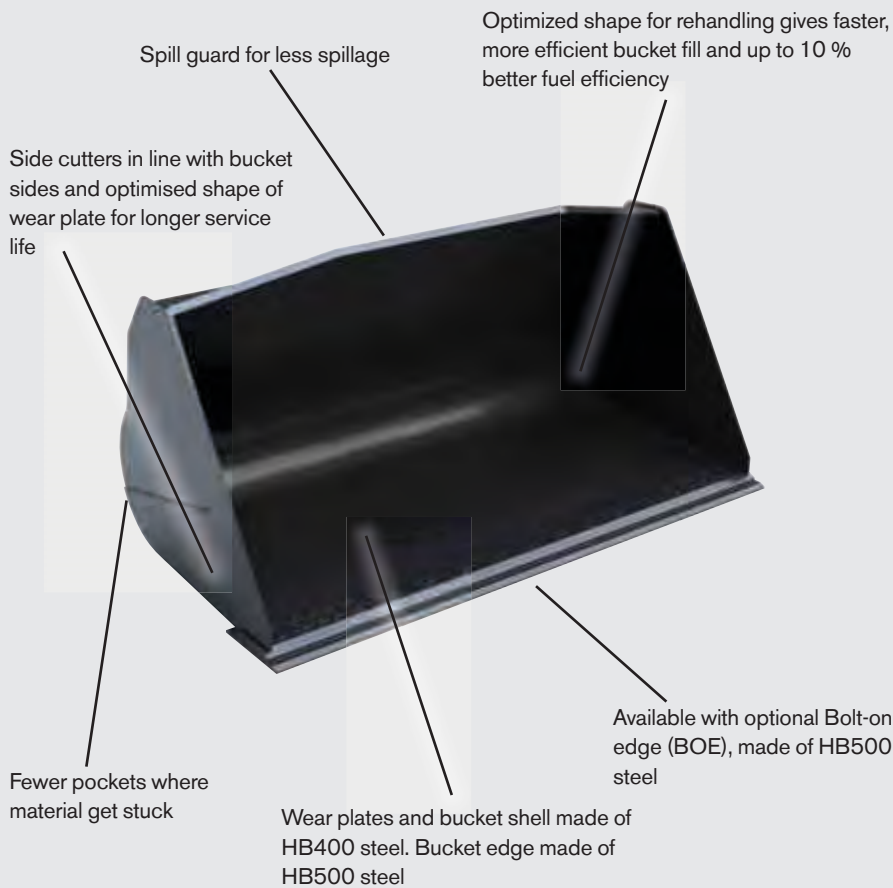

Volvo Tooth system

The Volvo patented vertical locking device makes mounting and removing fast and easy. For Volvo buckets there are also a wide selection of cutting edges and segments in high strength steel 500 HB to protect the bucket from wear.



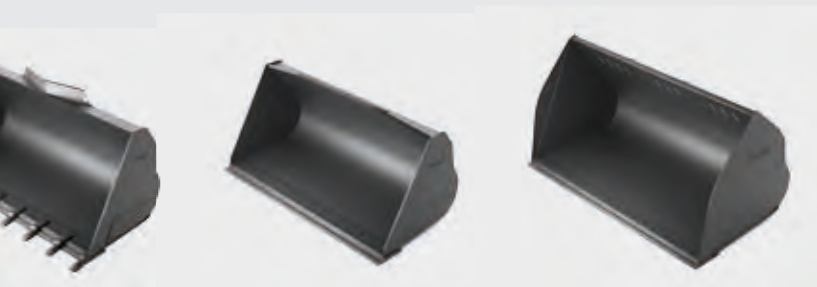

TWO MACHINES THAT HAVE IT ALL.

Automatic Power Shift

The machine always operates in the most suitable gear according to speed, kick down and engine braking to save fuel consumption.



Safe and roomy cab

ROPS/FOPS tested cab with conveniently-placed controls, noise reduction and premium air filter.



Productive TP linkage

High breakout torque, even at the highest lift position. Excellent link geometry gives excellent parallel movement.



CareTrack

CareTrack is the Volvo telematics system. It is equipped as standard on this machine and is designed to provide information to help improve productivity and efficiency.

Load-sensing hydraulics

Variable- flow axial piston pumps for superior control and high breakout force.

Electro hydraulic servo control

Mounted on the cab seat for comfortable operation and control.



* In markets where CareTrack is available

Contronics

Relays necessary diagnostics to the operator via a screen so problems can be found early to reduce down-time and improve safety.



Easy access to the engine

New electronic opening design for easy service access. Bigger ventilation panels keep the engine cool.



Optimized drivetrain

Engine, transmission, axles, hydraulics and steering are developed as one unit by Volvo to provide optimized performance and maximum reliability.

Diesel particulate filter

Includes a Diesel Oxidation catalyst function and an external regeneration burner to incinerate exhaust fumes and reduce emissions.



Lowering emissions

Stage IIIB/ Tier 4 Interim compliant engine for low fuel consumption and less emissions.

Heavy duty axle

Absorb the weight for optimal torque, reduced stresses and longer life.



TOP PERFORMANCE DESERVES SUPPORT.

The day you receive your new Volvo Wheel Loader is just the start of your working relationship with Volvo. From service and maintenance to our CareTrack telematics system – Volvo has a comprehensive and sophisticated aftermarket portfolio to continuously add value to your business.

Volvo designed and built your machines, so no-one knows how to keep them working in top condition more than us. When it comes to your machine, our Volvo trained technicians are the experts.

Our technicians work with industry leading diagnostic tools and techniques, using only Genuine Volvo Parts to deliver the highest levels of quality and service. Talk to your Volvo dealer about how genuine Volvo services can best provide the service and maintenance plan that is the right fit for you and your business.



State-of-the-art machines require state-of-the-art support and your Volvo dealer can provide a catalogue of services designed to get the most out of your machine, helping you maximise uptime, productivity and residual value. Your Volvo dealer can provide a number of sophisticated support offers, including:

Service plans ranging from routine wear inspections, through to comprehensive maintenance and repair agreements.

Analysis and diagnostics to help you understand how your machine is running, highlight potential maintenance issues and identify where performance can be improved.

Eco Operator training courses can help your operators work towards a safer, more productive and fuel efficient performance.



CareTrack*

Each Wheel Loader comes standard equipped with CareTrack, the Volvo telematics system. CareTrack provides information for better planning and smarter working; including fuel consumption reports, location reports and service reminders. Save fuel. Reduce costs. Maximise profitability. You can with CareTrack.

* In markets where CareTrack is available

VOLVO L110G, L120G IN DETAIL.



Engine

6-cylinder, 8 liters inline turbocharged diesel engine with an advanced fuel injection system with the common rail. Fuel is distributed under high pressure from a high-pressure accumulator, the rail. One camshaft-driven high pressure pump deliver the fuel to the rail and then further on via high-pressure pipes to the electro-hydraulically operated fuel injectors. Cooled exhaust gas recirculation and particulate filter with active and passive regeneration. **Air cleaning:** Three-stage Cyclone precleaner - primary filter - secondary filter **Cooling system:** Hydrostatic, electronically controlled fan and intercooler of the air-to-air type.

L110G

Engine		D8H (Tier 4i) D8H (Stage IIIB)
Max power at	r/s (r/min)	28,3 (1700)
SAE J1995 gross	kW / hp	191 (260)
ISO 9249, SAE J1349 net	kW / hp	190 (258)
Max torque at	r/s (r/min)	23,3 (1400)
SAE J1995 gross	Nm	1255
ISO 9249, SAE J1349	Nm	1248
Economic working range	r/min	850-2100
Displacement	l	7,75

L120G

Engine		D8H (Tier 4i) D8H (Stage IIIB)
Max power at	r/s (r/min)	28,3 (1700)
SAE J1995 gross	kW / hp	201 (273)
ISO 9249, SAE J1349 net	kW / hp	200 (272)
Max torque at	r/s (r/min)	25,0 (1500)
SAE J1995 gross	Nm	1320
ISO 9249, SAE J1349 net	Nm	1312
Economic working range	r/min	850-2100
Displacement	l	7,75

L110G

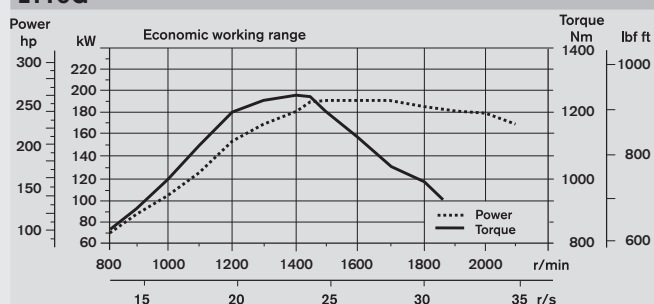

L120G

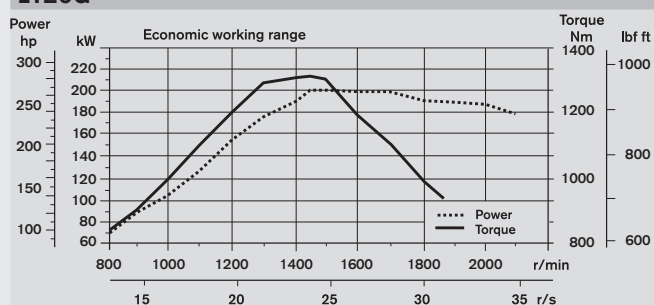



Drivetrain

Torque converter: Single-stage.

Transmission: Volvo countershaft transmission with single lever control. Fast and smooth shifting of gears with Pulse Width Modulation (PWM) valve.

Transmission: Volvo Automatic Power Shift (APS) with fully automatic shifting 1-4 and mode selector with 4 different gear shifting programs, including AUTO.

Axles: Volvo fully floating axle shafts with planetary hub reductions and cast steel axle housing. Fixed front axle and oscillating rear axle. 100% differential lock on the front axle.

L110G

Transmission	Volvo	HTE 206
Torque multiplication		2,47:1
Maximum speed, forward/reverse	1st gear	km/h 7,0
	2nd gear	km/h 13,5
	3rd gear	km/h 28,0
	4th gear*	km/h 40,0
Measured with tires		750/65R25
Front axle/rear axle		AWB 31/AWB 30
Rear axle oscillation ±	°	± 13
Ground clearance at 13° osc.	mm	460

L120G

Transmission	Volvo	HTE 206
Torque multiplication		2,47:1
Maximum speed, forward/reverse	1st gear	km/h 7,0
	2nd gear	km/h 13,5
	3rd gear	km/h 28,0
	4th gear*	km/h 40,0
Measured with tires		750/65R25
Front axle/rear axle		AWB 31/AWB 30
Rear axle oscillation ±	°	± 13
Ground clearance at 15° osc.	mm	460

* limited by ECU

Electrical system

Central warning system: Contronic electrical system with central warning light and buzzer for following functions: - Serious engine fault - Low steering system pressure - Over speed warning engine - Interruption in communication (computer fault) Central warning light and buzzer with the gear engaged for the following functions. - Low engine oil pressure - High engine oil temperature - High charge air temperature - Low coolant level - High coolant temperature - High crank case pressure - Low transmission oil pressure - High transmission oil temperature - Low brake pressure - Engaged parking brake - Fault on brake charging - Low hydraulic oil level - High hydraulic oil temperature - Overspeeding in engaged gear - High brake cooling oil temperature front and rear axles.

L110G, L120G

Voltage	V	24
Batteries	V	2 x 12
Battery capacity	Ah	2 x 170
Cold cranking capacity, approx	A	1000
Batteries		
Alternator rating	W/A	3420/110
Starter motor output	kW	5,5

Brake system

Service brake: Volvo dual-circuit system with nitrogen charged accumulators. Outboard mounted hydraulically operated, fully sealed oil circulation cooled wet disc brakes. The operator can select automatic declutch of the transmission when braking through a switch in the A-pillar.

Parking brake: Fully sealed, wet multi-disc brake built into the transmission. Applied by spring force, electro-hydraulically released with a switch on the instrument panel.

Secondary brake: Dual brake circuits with rechargeable accumulators. One circuit or the parking brake fulfills all safety requirements.

Standard: The brake system complies with the requirements of ISO 3450.

L110G

Number of brake discs per wheel		1
Accumulators		3 x 1,0

L120G

Number of brake discs per wheel		1
Accumulators		3 x 1,0

VOLVO L110G, L120G IN DETAIL.



Cab

Instrumentation: All important information is centrally located in the operator's field of vision. Display for Contronic monitoring system.

Heater and defroster: Heater coil with filtered fresh air and fan with auto and 11 speeds. Defroster vents for all window areas.

Operator's seat: Operator's seat with adjustable suspension and retractable seatbelt. The seat is mounted on a bracket on the rear cab wall and floor. The forces from the retractable seatbelt are absorbed by the seat rails.

Standard: The cab is tested and approved according to ROPS (ISO 3471, SAE J1040), FOPS (ISO 3449). The cab meets with requirements according to ISO 6055 (Operator overhead protection - Industrial trucks) and SAE J386 ("Operator Restraint System").

		L110G
Emergency exit:	Use emergency hammer to break window	
Sound level in cab according to ISO 6396/SAE J2105		
	dB(A)	68
External sound level according to ISO 6396/SAE J2105		
	dB(A)	106
Ventilation	m ³ /min	9
Heating capacity	kW	16
Air conditioning (optional)	kW	7,5

		L120G
Emergency exit:	Use emergency hammer to break window	
Sound level in cab according to ISO 6396/SAE J2105		
	LpA	68
External sound level according to ISO 6395/SAE J2104		
	LwA	106
Ventilation	m ³ /min	9
Heating capacity	kW	16
Air conditioning (optional)	kW	7,5

Lift arm system

Torque Parallel linkage (TP-linkage) with high breakout torque and parallel action throughout the entire lifting range.

		L110G
Lift cylinders		2
Cylinder bore	mm	150
Piston rod diameter	mm	80
Stroke	mm	676
Tilt cylinder		1
Cylinder bore	mm	210
Piston rod diameter	mm	110
Stroke	mm	412

		L120G
Lift cylinders		2
Cylinder bore	mm	150
Piston rod diameter	mm	80
Stroke	mm	676
Tilt cylinder		1
Cylinder bore	mm	210
Piston rod diameter	mm	110
Stroke	mm	412



Hydraulic system

System supply: Two load-sensing axial piston pumps with variable displacement. The steering system always has priority.

Valves: Double-acting 2-spool valve. The main valve is controlled by a 2-spool pilot valve.

Lift function: The valve has three positions; raise, hold and lower position. Inductive/magnetic automatic boom kickout can be switched on and off and is adjustable to any position between maximum reach and full lifting height.

Tilt function: The valve has three functions including rollback, hold and dump. Inductive/magnetic automatic tilt can be adjusted to the desired bucket angle.

Cylinders: Double-acting cylinders for all functions

Filter: Full flow filtration through 10 micron (absolute) filter cartridge.

		L110G	L120G
Working pressure maximum, pump 1 for working hydraulic system	MPa	27,0 ± 0,5	29,0 ± 0,5
Flow at engine speed	l/min	135	135
	MPa	10	10
Working pressure maximum, pump 2 for steering-, brake-, pilot- and working hydraulic system	MPa	29,0 ± 0,5	31,0 ± 0,5
Flow at engine speed	l/min	135	135
	MPa	10	10
Working pressure maximum, pump 3 for brake- and cooling fan system	MPa	21,0 ± 0,5	21,0 ± 0,5
Flow at engine speed	l/min	33	33
	MPa	10	10
Pilot system, working pressure	MPa	3,5	3,5
Cycle times			
Lift	s	5,4	5,4
Tilt	s	2,1	2,1
Lower, empty	s	2,5	2,5
Total cycle time	s	10,0	10,0

Steering system

Steering system: Load-sensing hydrostatic articulated steering.

System supply: The steering system has priority feed from a load-sensing axial piston pump with variable displacement.

Steering cylinders: Two double-acting cylinders.

		L110G	L120G
Steering cylinders			
Cylinder bore	mm	80	80
Rod diameter	mm	50	50
Stroke	mm	486	486
Working pressure	MPa	21,0	21,0
Maximum flow	l/min	120	120
Maximum articulation	± °	40	40

Service

Service accessibility: Large, easy-to-open hood covering whole engine department, electrically operated. Fluid filters and component breather air filters promote long service intervals. Possibility to monitor, log and analyze data to facilitate troubleshooting.

		L110G	L120G
Fuel Tank	l	269	269
Engine coolant	l	43	43
Hydraulic oil tank	l	133	133
Transmission oil	l	38	38
Engine oil	l	22	22
Axle oil front	l	36	36

SPECIFICATIONS L110G.

Tires 23.5 R25 L3

		Standard boom	Long boom
B	mm	6480	7010
C	mm	3200	-
D	mm	430	-
F	mm	3380	-
G	mm	2132	-
J	mm	3710	4240
K	mm	4030	4550
O	°	55	-
P _{max}	°	50	-
R	°	40	41
R ₁ *	°	45	-
S	°	66	64
T	mm	80	89
U	mm	480	-
X	mm	2070	-
Y	mm	2670	-
Z	mm	3310	3820
a ₂	mm	5730	-
a ₃	mm	3060	-
a ₄	±°	40	-

* Carry position SAE

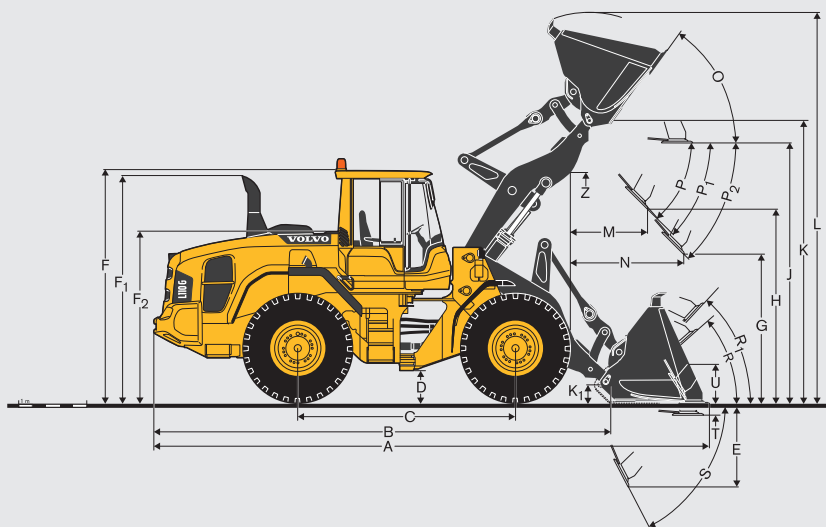

Where applicable, specifications and dimensions are according to ISO 7131, SAE J732, ISO 7546, SAE J742, ISO 14397, SAE J818.

L110G Sales code: WLA80832
 Operating weight
 (incl. logging cw 1 140 kg): 19 840 kg
 Operating load: 5 850 kg

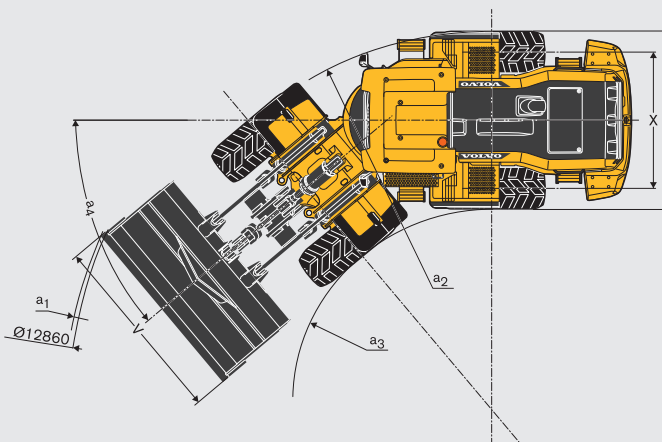





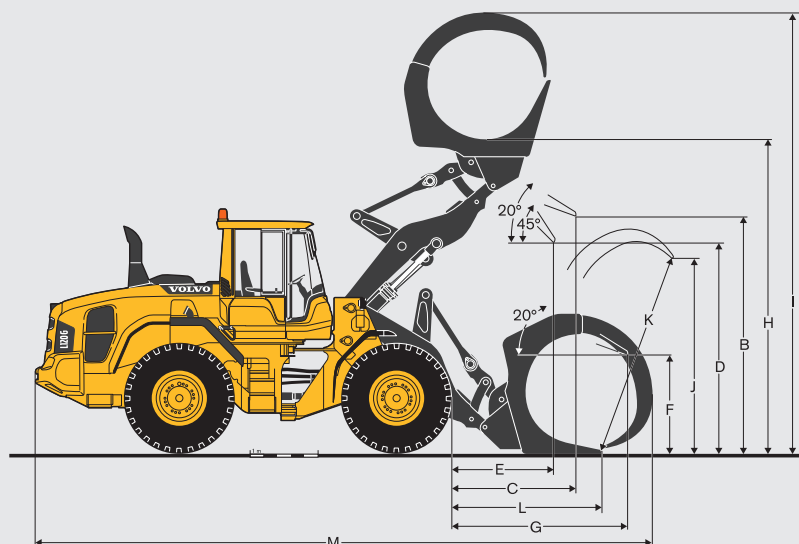



Tires: 750/65 R25

A	m ²	2,4
B	mm	3470
C	mm	1850
D	mm	2850
E	mm	1460
F	mm	1520
G	mm	2720
H	mm	4580
I	mm	6620
J	mm	2790
K	mm	2990
L	mm	2060
M	mm	8770







L110G

Tires 23.5R25 XHA2 L3	REHANDLING		GENERAL PURPOSE				ROCK	LIGHT MATERIAL		LONG BOOM	
											
	3,5 m ³ STE P BOE	3,5 m ³ STE H BOE	3 m ³ STE P T	3 m ³ STE H T	3,4 m ³ STE P BOE	3,4 m ³ STE H BOE	2,7 m ³ SPN P T SEG	5,5 m ³ LM H	9,5 m ³ LM H		
Volume, heaped ISO/SAE	m ³	3,5	3,5	3,0	3,0	3,4	3,4	2,7	5,5	9,5	
Volume at 110% fill factor	m ³	3,9	3,9	3,3	3,3	3,7	3,7	3,0	6,1	10,5	
Static tipping load, straight	kg	13340	12670	13670	12990	13230	12570	13670	11870	11960	-2680
at 35° turn	kg	11850	11230	12170	11540	11750	11140	12130	10450	10510	-2450
at full turn	kg	11420	10810	11730	11110	11320	10710	11680	10040	10090	-2380
Breakout force	kN	162,1	149,8	174,8	160,4	157,7	145,9	143,1	115,3	100,6	
A	mm	7970	8080	8090	8200	8010	8120	8310	8520	8810	610
E	mm	1220	1320	1340	1440	1260	1360	1510	1710	1970	
H	mm	2820	2750	2740	2670	2790	2720	2610	2410	2200	520
L	mm	5440	5510	5550	5610	5620	5670	5550	5830	6000	510
M	mm	1170	1250	1280	1370	1200	1280	1400	1520	1730	430
N	mm	1710	1750	1790	1820	1730	1770	1810	1790	1800	430
V	mm	3000	3000	2880	2880	2880	2880	2880	3000	3400	
a1 clearance circle	mm	12750	12800	12710	12770	12660	12710	12830	13060	13610	
Operating weight	kg	18420	18650	18280	18490	18480	18690	19490	19030	19250	300

Bucket Selection Chart

The chosen bucket is determined by the density of the material and the expected bucket fill factor. The actual bucket volume is often larger than the rated capacity, due to the features of the TP linkage, including an open bucket design, good rollback angles in all positions and good bucket filling performance. The example represents a standard boom configuration.
 Example: Sand and gravel. Fill factor ~ 105%. Density 1,6 t/m³.
 Result: The 3,4 m³ bucket carries 3,6 m³. For optimum stability always consult the bucket selection chart.

Material	Bucket fill, %		Material density, t/m ³	ISO/SAE bucket volume, m ³	Actual volume, m ³
Earth/Clay	~ 110		1,8	3,0	3,3
			1,6	3,4	3,7
Sand/Gravel	~ 105		1,8	3,0	3,2
			1,6	3,4	3,6
Aggregate	~ 100		1,6	3,5	3,5
Rock	≤100		1,7	2,7	2,7

The size of rock buckets is optimized for optimal penetration and filling capability rather than the density of the material.

Supplemental Operating Data

		Standard boom		Long boom
Tires 23.5 R25 L3		23.5 R25 L5	750/65 R25	750/65 R25
Width over tires	mm	+30	+200	+200
Ground clearance	mm	+50	±0	±0
Tipping load, full turn	kg	+490	+430	+310
Operating weight	kg	+670	+640	+640

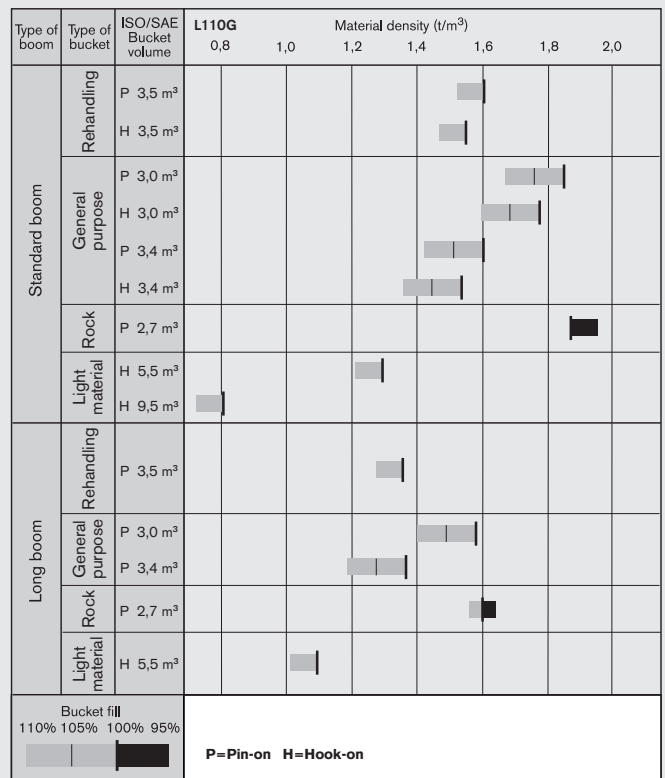

How to read bucket fill factor

SPECIFICATIONS L120G.

Tires 23.5 R25 L3

		Standard boom	Long boom
B	mm	6580	7067
C	mm	3200	-
D	mm	440	-
F	mm	3380	-
G	mm	2132	-
J	mm	3770	4306
K	mm	4100	4618
O	°	54	-
P _{max}	°	51	-
R	°	42	42,5
R ₁ *	°	47	-
S	°	67	63,9
T	mm	104	134
U	mm	510	-
X	mm	2070	-
Y	mm	2670	-
Z	mm	3340	3715
a ₂	mm	5730	-
a ₃	mm	3060	-
a ₄	±°	40	-

* Carry position SAE

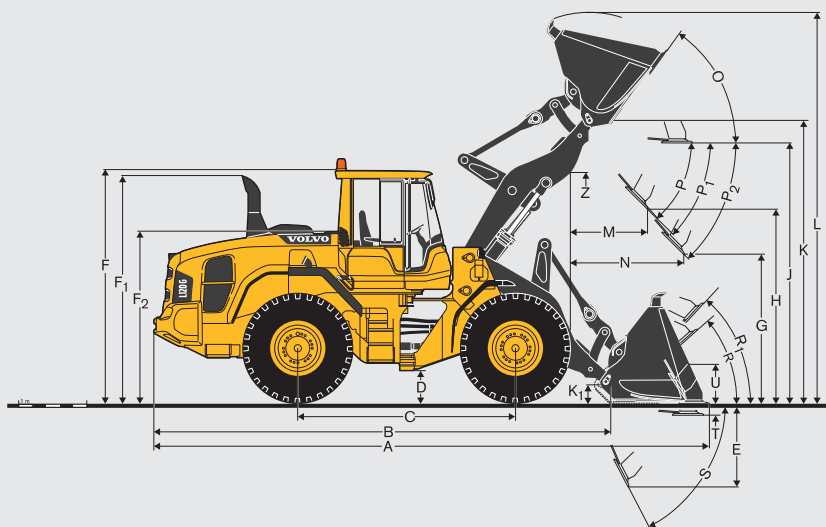

Where applicable, specifications and dimensions are according to ISO 7131, SAE J732, ISO 7546, SAE J742, ISO 14397, SAE J818.

L120G Sales code: WLA80832
 Operating weight
 (incl. logging cw 680 kg): 20 600 kg
 Operating load: 6400 kg

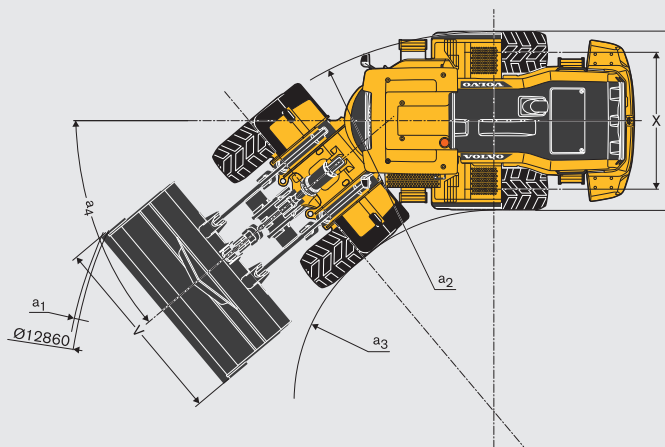





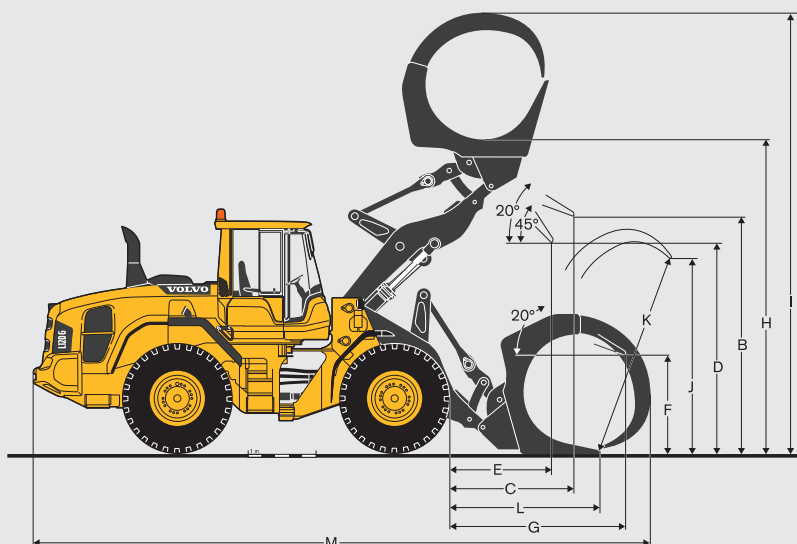



Tires: 750/65 R25

A	m ²	2,4
B	mm	3470
C	mm	1850
D	mm	2850
E	mm	1460
F	mm	1520
G	mm	2720
H	mm	4580
I	mm	6620
J	mm	2790
K	mm	2990
L	mm	2060
M	mm	8770







L120G

Tires 23.5R25 XHA2 L3	REHANDLING		GENERAL PURPOSE				ROCK	LIGHT MATERIAL		LONG BOOM	
											
	3,8 m³ STE P BOE	3,8 m³ STE H BOE	3,3 m³ STE P T	3,3 m³ STE H T	3,6 m³ STE P BOE	3,6 m³ STE H BOE	3 m³ SPN P T SEG	5,5 m³ LM H	9,5 m³ LM H		
Volume, heaped ISO/SAE	m³	3,8	3,8	3,3	3,3	3,6	3,6	3,0	5,5	9,5	
Volume at 110% fill factor	m³	4,2	4,2	3,6	3,6	4,0	4,0	3,3	6,1	10,5	
Static tipping load, straight	kg	14250	13570	14730	14390	14700	13970	14750	12910	13010	-2750
at 35° turn	kg	12610	11980	13070	12740	13010	12330	13060	11350	11420	-2510
at full turn	kg	12130	11510	12580	12250	12510	11850	12570	10880	10950	-2440
Breakout force	kN	163,7	151,8	188,0	172,4	172,9	159,6	150,6	121,6	106,1	
A	mm	8140	8240	8170	8270	8050	8160	8390	8610	8910	500
E	mm	1300	1400	1330	1430	1230	1330	1520	1730	2000	30
H	mm	2840	2770	2830	2760	2900	2830	2690	2470	2270	520
L	mm	5580	5640	5700	5760	5750	5820	5690	5900	6070	510
M	mm	1250	1330	1300	1390	1190	1280	1440	1560	1760	-25
N	mm	1820	1860	1870	1910	1800	1840	1920	1890	1910	430
V	mm	3000	3000	3000	3000	3000	3000	2880	3000	3400	
a1 clearance circle	mm	12840	12900	12870	12930	12800	12850	12890	13130	13660	
Operating weight	kg	19300	19520	19170	19350	19350	19570	20190	19830	20050	280

Bucket Selection Chart

The chosen bucket is determined by the density of the material and the expected bucket fill factor. The actual bucket volume is often larger than the rated capacity, due to the features of the TP linkage, including an open bucket design, good rollback angles in all positions and good bucket filling performance. The example represents a standard boom configuration.

Example: Sand and gravel. Fill factor ~ 105%. Density 1,6 t/m³.
Result: The 4,0 m³ bucket carries 4,2 m³. For optimum stability always consult the bucket selection chart.

Material	Bucket fill, %		Material density, t/m³	ISO/SAE bucket volume, m³	Actual volume, m³
Earth/Clay	~ 110		1,8	3,3	3,6
			1,6	3,6	3,9
Sand/Gravel	~ 105		1,8	3,3	3,5
			1,6	3,6	3,8
Aggregate	~ 100		1,6	3,8	3,8
Rock	≤100		1,7	3,0	3,0

The size of rock buckets is optimized for optimal penetration and filling capability rather than the density of the material.

Supplemental Operating Data

		Standard boom		Long boom
		23.5 R25 L5	750/65 R25	750/65 R25
Tires 23.5 R25 L3				
Width over tires	mm	+30	+200	+200
Ground clearance	mm	+50	±0	±0
Tipping load, full turn	kg	+450	+380	+330
Operating weight	kg	+670	+640	+640

Type of boom	Type of bucket	ISO/SAE Bucket volume	L120G Material density (t/m³)									
			0,6	0,8	1,0	1,2	1,4	1,6	1,8			
Standard boom	Rehandling	P 3,8 m³										
		H 3,8 m³										
	General purpose	P 3,3 m³										
		H 3,3 m³										
	Rock	P 3,0 m³										
		H 3,0 m³										
Long boom	Light material	P 5,5 m³										
		H 5,5 m³										
	Rehandling	P 3,8 m³										
		H 3,8 m³										
	General purpose	P 3,3 m³										
		H 3,3 m³										
Rock	P 3,0 m³											
	H 3,0 m³											
Light material	P 5,5 m³											
	H 5,5 m³											

How to read bucket fill factor

EQUIPMENT.

STANDARD EQUIPMENT

	L110G	L120G
Service and maintenance		
Engine oil remote drain and fill	•	•
Transmission oil remote drain and fill	•	•
Lubrication manifolds, ground accessible	•	•
Pressure check connections: transmission and hydraulic, quick-connects	•	•
Tool box, lockable	•	•
CareTrack	•	•
Telematics, 3-Year Subscription	•	•
Engine		
Exhaust after-treatment system	•	•
Three stage air cleaner, pre-cleaner, primary and secondary filter	•	•
Indicator for coolant level	•	•
Preheating of induction air	•	•
Fuel pre-filter with water trap	•	•
Fuel filter	•	•
Crankcase breather oil trap	•	•
Exterior radiator air intake protection	•	•
Electrical system		
24 V, pre-wired for optional accessories	•	•
Alternator 24V/110A	•	•
Battery disconnect switch with removable key	•	•
Fuel gauge	•	•
Hour meter	•	•
Electric horn	•	•
Instrument cluster:	•	•
Fuel level		
Transmission temperature		
Coolant temperature		
Instrument lighting		
Lighting:	•	•
Halogen front headlights with high and low beams		
Parking lights		
Brake and tail lights		
Turn signals with flashing hazard light function		
Halogen work lights (2 front and 2 rear)		
Contronic monitoring system		
Monitoring and logging of machine data	•	•
Contronic display	•	•
Fuel consumption	•	•
Ambient temperature	•	•
Clock	•	•
Test function for warning and indicator lights	•	•
Brake test	•	•
Test function, sound level at max fan speed	•	•
Warning and indicator lights:	•	•
Battery charging		
Parking brake		
Warning and display message:	•	•
Regeneration		
Engine coolant temperature		
Charge-air temperature		
Engine oil temperature		
Engine oil pressure		
Transmission oil temperature		
Transmission oil pressure		
Hydraulic oil temperature		
Brake pressure		
Parking brake applied		
Brake charging		
Overspeed at direction change		
Axle oil temperature		
Steering pressure		
Crankcase pressure		
Attachment lock open		
Level warnings:	•	•
Fuel level		
Engine oil level		
Engine coolant level		
Transmission oil level		
Hydraulic oil level		
Washer fluid level		
Engine torque reduction in case of malfunction indication:	•	•
High engine coolant temperature		
High engine oil temperature		

Low engine oil pressure		
High crankcase pressure		
High charge-air temperature		
Engine shutdown to idle in case of malfunction indication:	•	•
High transmission oil temperature		
Slip in transmission clutches		
Keypad, background lit	•	•
Start interlock when gear is engaged	•	•
Drivetrain		
Automatic Power Shift	•	•
Fully automatic gearshifting, 1-4	•	•
PWM-controlled gearshifting	•	•
Forward and reverse switch by hydraulic lever console	•	•
Indicator glass for transmission oil level	•	•
Differentials:	•	•
Front, 100% hydraulic diff lock. Rear, conventional.		
Brake system		
Dual brake circuits	•	•
Dual brake pedals	•	•
Secondary brake system	•	•
Parking brake, electrical-hydraulic	•	•
Brake wear indicators	•	•
Cab		
ROPS (ISO 3471), FOPS (ISO 3449)	•	•
Single key kit door/start	•	•
Acoustic inner lining	•	•
Ashtray	•	•
Cigarette lighter, 24 V power outlet	•	•
Lockable door	•	•
Cab heating with fresh air inlet and defroster	•	•
Fresh air inlet with two filters	•	•
Automatic heat control	•	•
Floor mat	•	•
Dual interior lights	•	•
Dual interior rear-view mirrors	•	•
Dual exterior rear-view mirrors	•	•
Sliding window, right side	•	•
Tinted safety glass	•	•
Retractable seatbelt (SAE J386)	•	•
Adjustable steering wheel	•	•
Storage compartment	•	•
Document pocket	•	•
Sun visor	•	•
Beverage holder	•	•
Windshield washer front and rear	•	•
Windshield wipers front and rear	•	•
Interval function for front and rear wipers	•	•
Hydraulic system		
Main valve, double acting 2-spool with hydraulic pilots	•	•
Variable displacement axial piston pumps (3) for:	•	•
1 Working hydraulic system		
2 Working hydraulic system,		
Steering and Brake system		
3 Cooling fan and Brake system		
Electro-hydraulic servo controls	•	•
Electric level lock	•	•
Boom kick-out, automatic	•	•
Bucket positioner, automatic	•	•
Double-acting hydraulic cylinders	•	•
Indicator glass for hydraulic oil level	•	•
Hydraulic oil cooler	•	•
External equipment		
Fenders, front and rear	•	•
Viscous cab mounts	•	•
Rubber engine and transmission mounts	•	•
Easy-to-open engine hood	•	•
Frame, joint lock	•	•
Vandalism lock prepared for	•	•
Batteries		
Engine compartment		
Radiator grille		
Lifting eyes	•	•
Tie-down eyes	•	•
Tow hitch	•	•
Counterweight, pre-drilled for optional guards	•	•

OPTIONAL EQUIPMENT

	L110G	L120G
Service and maintenance		
Automatic lubrication system	•	•
Automatic lubrication system for long boom	•	•
Grease nipple guards	•	•
Oil sampling valve	•	•
Refill pump for grease to lube system	•	•
Tool kit	•	•
Wheel nut wrench kit	•	•
Engine		
Air pre-cleaner, cyclone type	•	•
Air pre-cleaner, oil-bath type	•	•
Air pre-cleaner, turbo type	•	•
Radiator corrosion protection	•	•
Engine auto shutdown	•	•
Engine block heater 230V/110V	•	•
ESW, Disabled engine protection	•	•
Air intake protection (for grill in waste)	•	•
Fuel fill strainer	•	•
Fuel heater	•	•
Hand throttle control	•	•
Max. fan speed, hot climate	•	•
Radiator, corrosion-protected	•	•
Reversible cooling fan	•	•
Reversible cooling fan and axle oil cooler	•	•
Electrical system		
Anti-theft device	•	•
Headlights, assym. left	•	•
License plate holder, lighting	•	•
Rear view camera incl. monitor, colour	•	•
Rear-view mirrors, adjustable, el.heated	•	•
Rear view mirrors, Long arm	•	•
Rear view mirrors, adjustable, el.heated, Long arm	•	•
Reduced function working lights, reverse gear activated	•	•
Reverse alarm	•	•
Reverse warning light, strobe lighting	•	•
Shortened headlight support brackets	•	•
Side marker lamps	•	•
Rotating beacon	•	•
Working lights, attachments	•	•
Working lights front, high intensity discharge (HID)	•	•
Working lights front, on cab, dual	•	•
Working lights front, extra	•	•
Working lights rear, on cab	•	•
Working lights rear, on cab, dual	•	•
Cab		
Anchorage for Operator's manual	•	•
Automatic Climate Control, ACC	•	•
ACC control panel, with Fahrenheit scale	•	•
Asbestos dust protection filter	•	•
Cab air pre-cleaner, cyclone type	•	•
Carbon filter	•	•
Cab roof, heavy-duty	•	•
Cover plate, under cab	•	•
Lunch box holder	•	•
Armrest, operator's seat, ISRI, left only	•	•
Operator's seat, KAB, air susp, heavy-duty, for CDC and/or elsevo	•	•
Radio installation kit incl. 11 amp 12 volt outlet, left side	•	•
Radio installation kit incl. 11 amp 12 volt outlet, right side	•	•
Radio installation kit incl. 20 amp 12 volt outlet	•	•
Radio with CD-player	•	•
Seatbelt, 3", (width 75 mm)	•	•
Steering wheel knob	•	•
Sun blinds, rear windows	•	•
Sun blinds, side windows	•	•
Timer cab heating	•	•
Window, sliding, door	•	•
Universal door/ignition key	•	•
Front view mirror	•	•

Drivetrain

Diff lock front 100%, Limited Slip rear	•	•
Speed limiter, 20 km/h	•	•
Speed limiter, 30 km/h	•	•
Speed limiter, 40 km/h	•	•
Wheel/axle seal guards	•	•

Brake system

Oil cooler and filter front & rear axle	•	•
Stainless steel, brake lines	•	•

Hydraulic system

Attachment bracket, welded	•	•
Boom suspension system	•	•
Separate attachment locking, standard boom	•	•
Separate attachment locking, long boom	•	•
Arctic kit, attachment locking hoses and 3rd hydr. function	•	•
Arctic kit, pilot hoses and brake accum. incl. hydr. oil	•	•
Boom cylinder hose and tube guards	•	•
Boom cylinder hose and tube guards for long boom	•	•
Hydraulic fluid, biodegradable, Volvo	•	•
Hydraulic fluid, fire-resistant	•	•
Hydraulic fluid, for hot climate	•	•
Electro-hydraulic function, 3rd	•	•
Electro-hydraulic function, 3rd for long boom	•	•
Electro-hydraulic function, 3rd-4th	•	•
Electro-hydraulic function, 3rd-4th for long boom	•	•

External equipment

Cab ladder, rubber-suspended	•	•
Deleted front mudguards & wideners rear	•	•
Mudguard widener, front/rear for 80-series tires	•	•
Mudguard widener, front/rear for 65-series tires	•	•
Fire suppression system	•	•
Mudguards, full cover, rear for 80-series tires	•	•
Mudguards, full cover, rear for 65-series tires	•	•
Long boom	•	•

Protective equipment

Belly guard front	•	•
Belly guard rear	•	•
Cover plate, heavy-duty, front frame	•	•
Cab roof heavy duty	•	•
Guards for front headlights	•	•
Guards for radiator grill	•	•
Guards for tail lights	•	•
Windows, side and rear guards	•	•
Windshield guard	•	•
Corrosion protection, painting of machine	•	•
Corrosion protection, painting of attachment bracket	•	•
Bucket Teeth protection	•	•

Other equipment

CE-marking	•	•
Comfort Drive Control (CDC)	•	•
Counterweight, logging	•	•
Counterweight, signal painted, chevrons	•	•
Secondary steering with automatic test function	•	•
Sound decal, EU	•	•
Noise reduction kit, exterior	•	•
Sign, slow moving vehicle	•	•
CareTrack, GSM	•	•
CareTrack, GSM/Satellite	•	•

Tires

23.5 R25	•	•
750/65 R25	•	•

EQUIPMENT.

OPTIONAL EQUIPMENT

	L110G	L120G
Attachments		
Buckets:		
Rock straight or spade nose	•	•
General purpose	•	•
Re-handling	•	•
Side-dump		
Light material	•	•
Wear parts:		
Bolt-on and weld-on bucket teeth	•	•
Segments	•	•
Cutting edge in three sections, bolt-on	•	•
Fork equipment	•	•
Material handling arm	•	•
Log grapples	•	•

SELECTION OF VOLVO OPTIONAL EQUIPMENT



Comfort Drive Control (CDC)

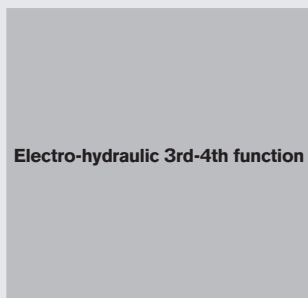
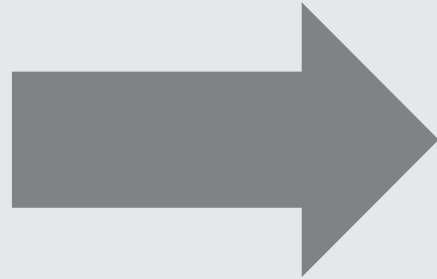

Electro-hydraulic 3rd-4th function

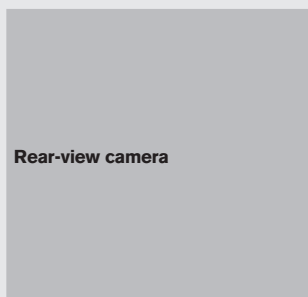

Rear-view camera

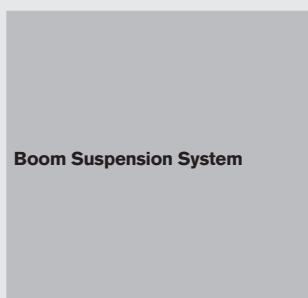

Boom Suspension System

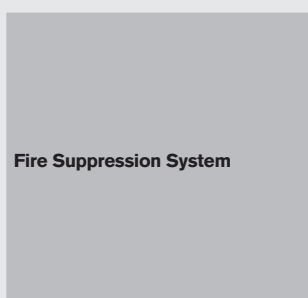
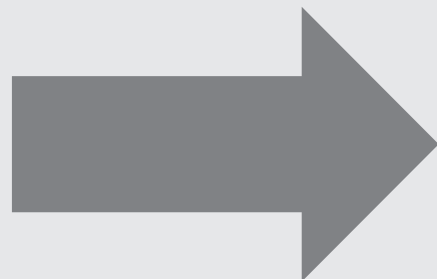

Fire Suppression System

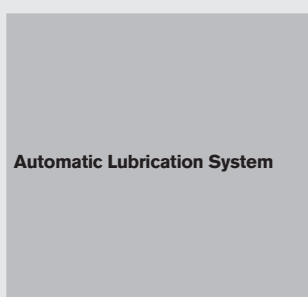

Automatic Lubrication System





VOLVO CONSTRUCTION EQUIPMENT

Volvo Construction Equipment is different. Our machines are designed, built and supported in a different way. That difference comes from an engineering heritage of over 175 years. A heritage of thinking first about the people who actually use the machines. About how to help them be safer, more comfortable, more productive. About the environment we all share. The result of that thinking is a growing range of machines and a global support network dedicated to helping you do more. People around the world are proud to use Volvo. And we're proud of what makes Volvo different.

Not all products are available in all markets. Under our policy of continuous improvement, we reserve the right to change specifications and design without prior notice. The illustrations do not necessarily show the standard version of the machine.

VOLVO

Volvo Construction Equipment
www.volvoce.com

Ref. No 20026571-B
2011.11
Volvo, Global Marketing

English-21
WLO